

ASTRAGALS

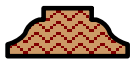

L203
1/4 X 5/8

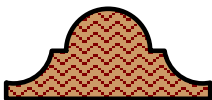

L205
7/16 X 1 1/8

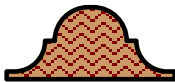

L204
3/8 X 7/8

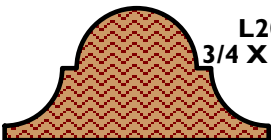

L206
3/4 X 1 3/8

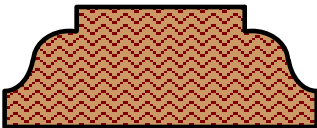

L207
5/8 X 1 5/8

BASE MOULDINGS

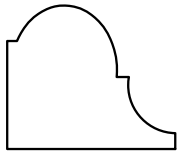

L155
3/4 X 7/8

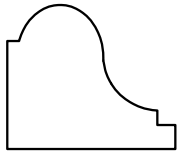

L156
3/4 X 7/8

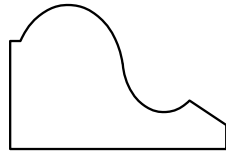

L157
3/4 X 1 1/8

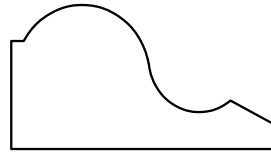

L158
3/4 X 1 3/8

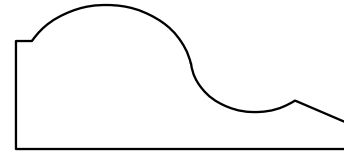

L159
3/4 X 1 3/4

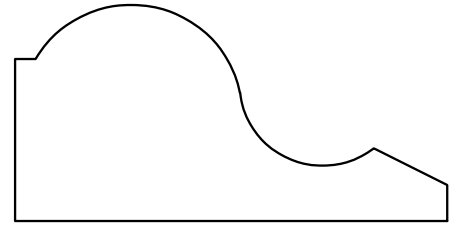

L160
1 1/8 X 2 1/4

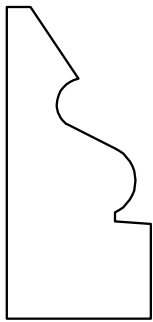

L161
3/4 X 1 5/8

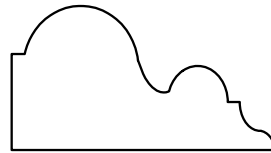

L162
3/4 X 1 3/8

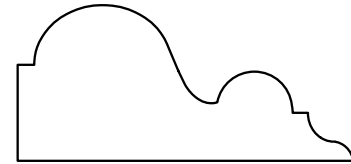

L163
3/4 X 1 3/4

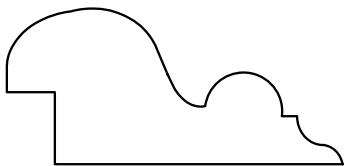

L164
3/4 X 1 3/4

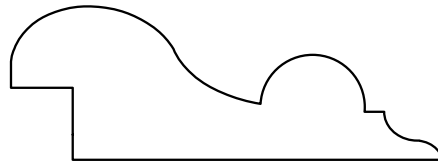

L165
3/4 X 2 1/4

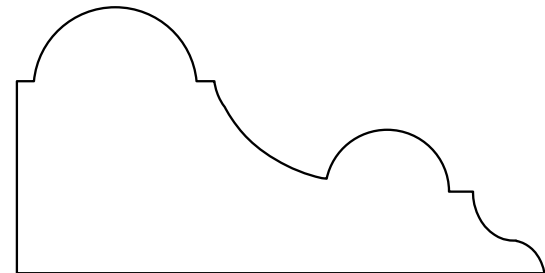

L166
1 3/8 X 2 3/4

BACK BAND MOULDINGS

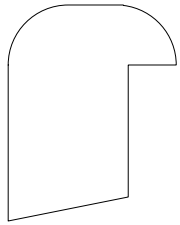

L53
3/4 X 1 1/8

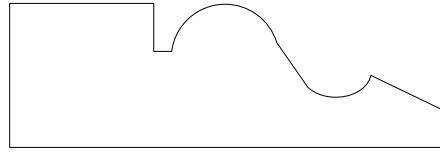

L54
3/4 X 2 1/4

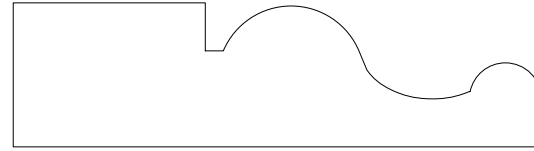

L55
3/4 X 2 3/4

CORNER GUARDS

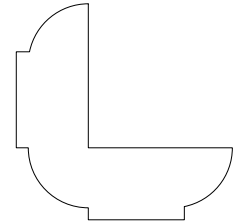

L129
1 1/8 X 1 1/8

GLASS MOULDINGS



L130
1/4 X 3/8



L131
3/8 X 1/2



L132
5/16 X 7/16



L133
3/8 X 5/8



L134
1/4 X 1/2

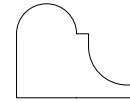

L135
1/2 X 5/8

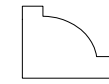

L136
3/8 X 1/2

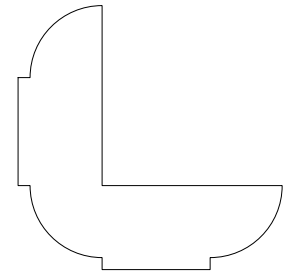

L128
1 3/8 X 1 3/8



L137
3/8 X 3/4



L138
3/8 X 5/8

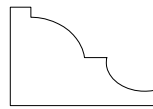

L139
7/16 X 5/8

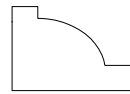

L140
7/16 X 5/8

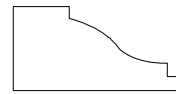

L141
7/16 X 7/8

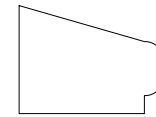

L142
9/16 X 3/4

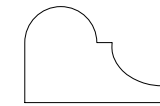

L143
1/2 X 3/4

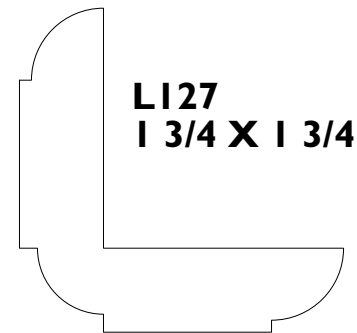

L127
1 3/4 X 1 3/4

O.G. MOULDING

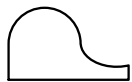

L230
3/8 X 5/8



L231
5/8 X 3/4

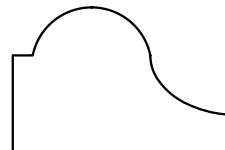

L232
3/4 X 1 1/8

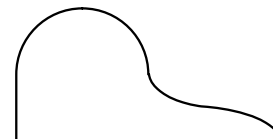

L233
1 1/16 X 1 3/8

21 AUGUST 96

ACTUAL SCALE

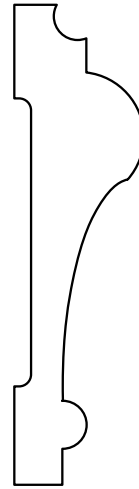

L214
3/4 X 2 1/2

HALF ROUNDS



L29
3/16 X 3/8



L30
1/4 X 1/2



L31
5/16 X 5/8

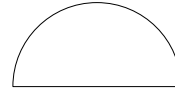

L33
7/16 X 7/8

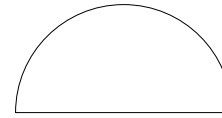

L34
9/16 X 1 1/8



L35
3/8 X 1 1/8

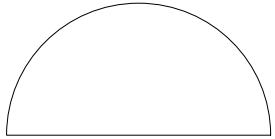

L36
11/16 X 1 3/8

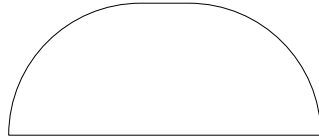

L37
11/16 X 1 5/8

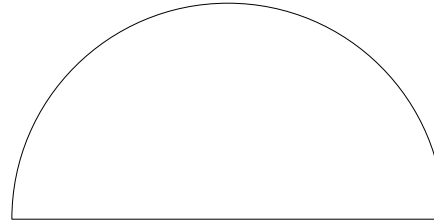

L38
1 1/8 X 2 1/4

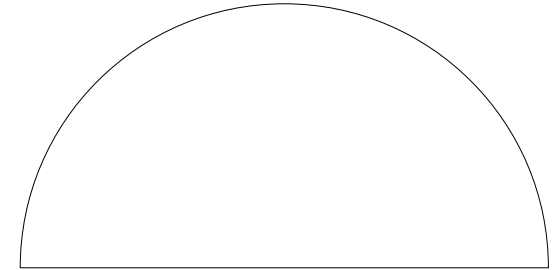

L39
1 3/8 X 2 3/4

QUARTER ROUNDS



L44
1/4 X 1/4



L45
3/8 X 3/8

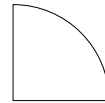

L46
1/2 X 1/2

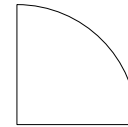

L47
5/8 X 5/8

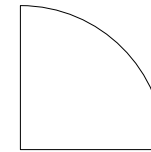

L48
3/4 X 3/4

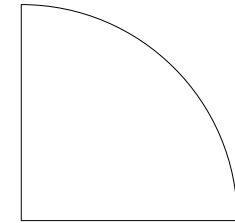

L49
1 1/8 X 1 1/8

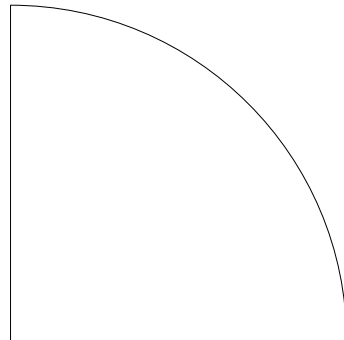

L51
1 3/4 X 1 3/4

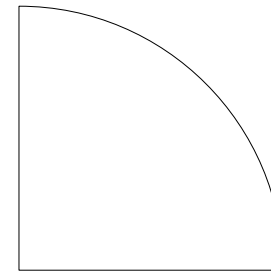

L50
1 3/8 X 1 3/8

CROWN MOULDINGS

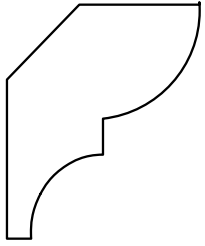

L144
1 1/16 X 1 5/8

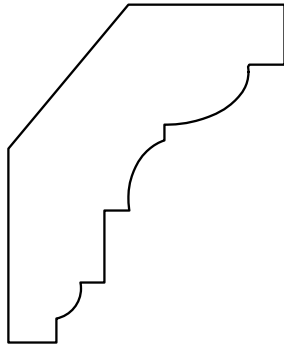

L145
3/4 X 2 1/4

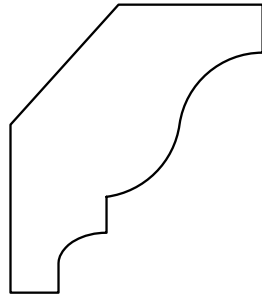

L146
3/4 X 2

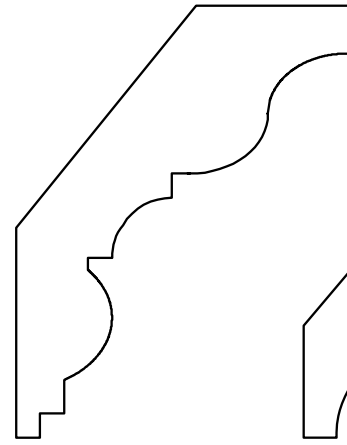

L147
3/4 X 2 3/4

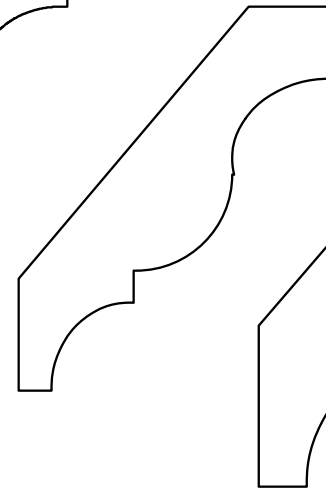

L148
1 1/16 X 2 5/8

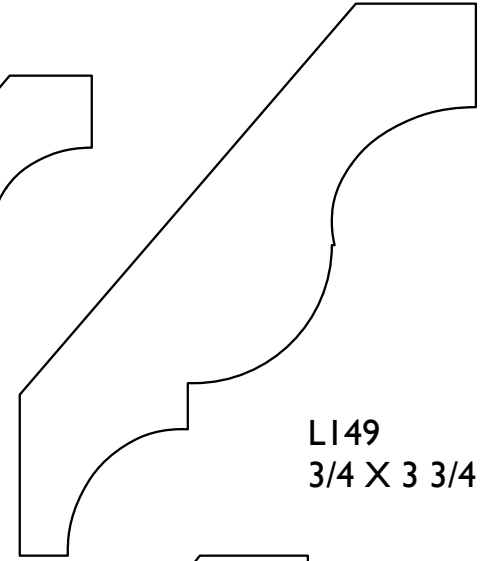

L149
3/4 X 3 3/4

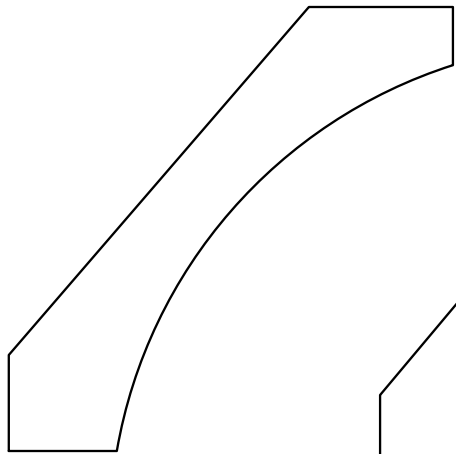

L150
3/4 X 3 1/4

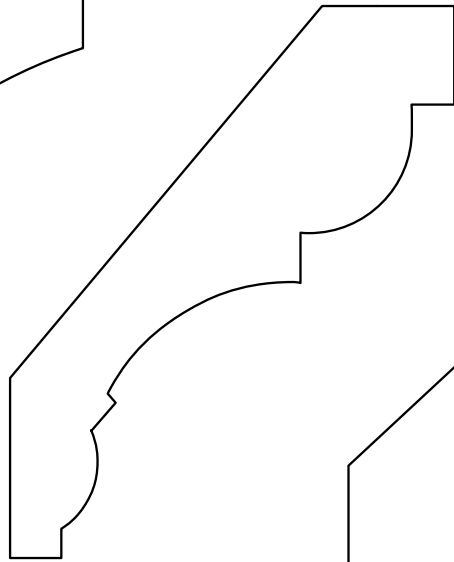

L151
3/4 X 3 3/4

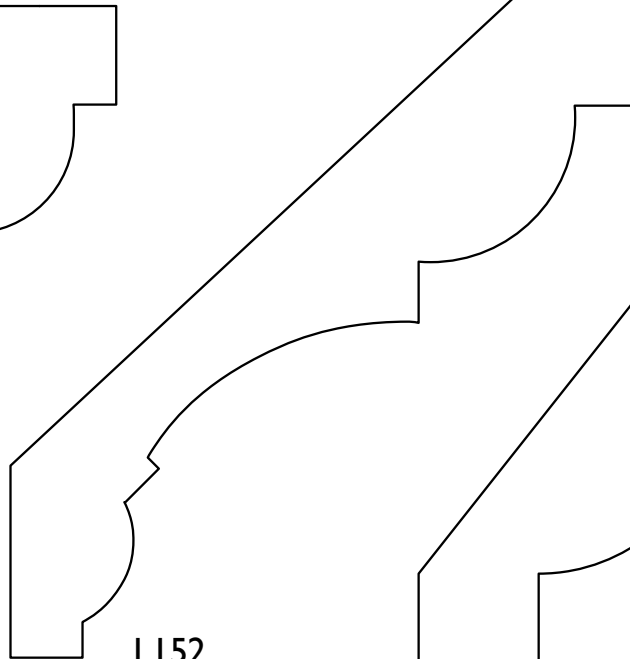

L152
3/4 X 4 3/4

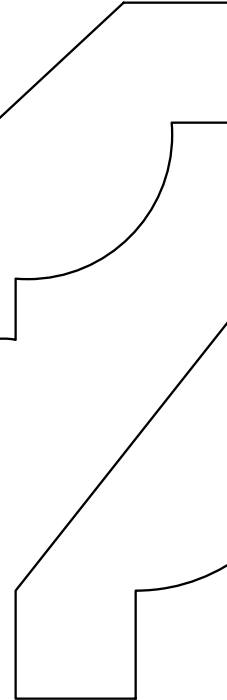

L153
3/4 X 5 3/4

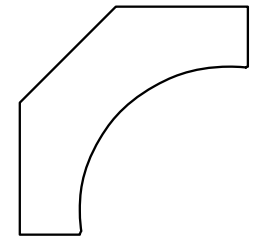

L154
1 1/16 X 1 5/8

15 AUGUST 96

ACTUAL SCALE

SOLID CROWNS

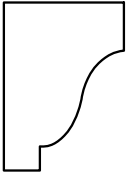

L115
5/8 X 7/8

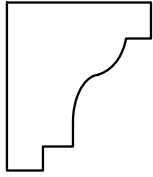

L116
3/4 X 7/8

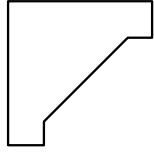

L117
3/4 X 3/4



L118
3/4 X 1 1/8

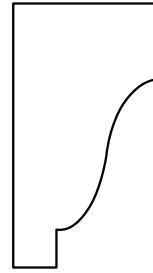

L119
3/4 X 1 3/8

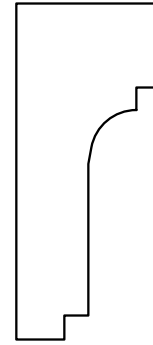

L120
3/4 X 1 3/4

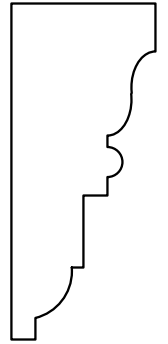

L121
3/4 X 1 3/4

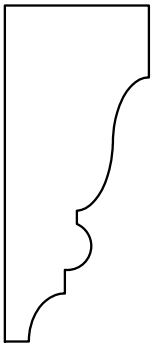

L122
3/4 X 1 3/4

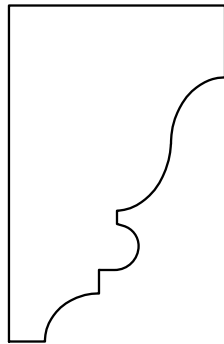

L123
1 1/8 X 1 3/4

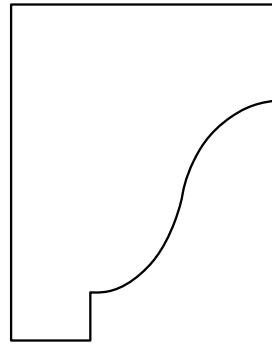

L124
1 3/8 X 1 3/4

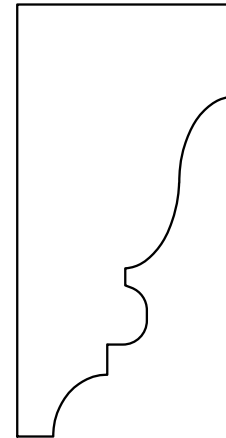

L125
1 1/8 X 2 1/4

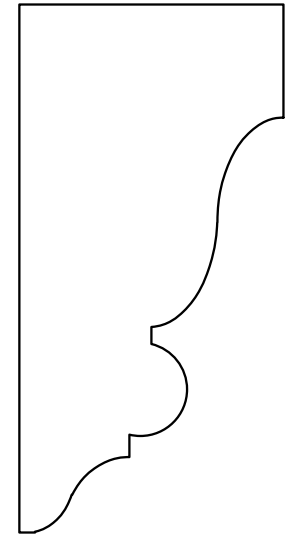

L126
1 3/8 X 2 3/4

TRIM AND CASING

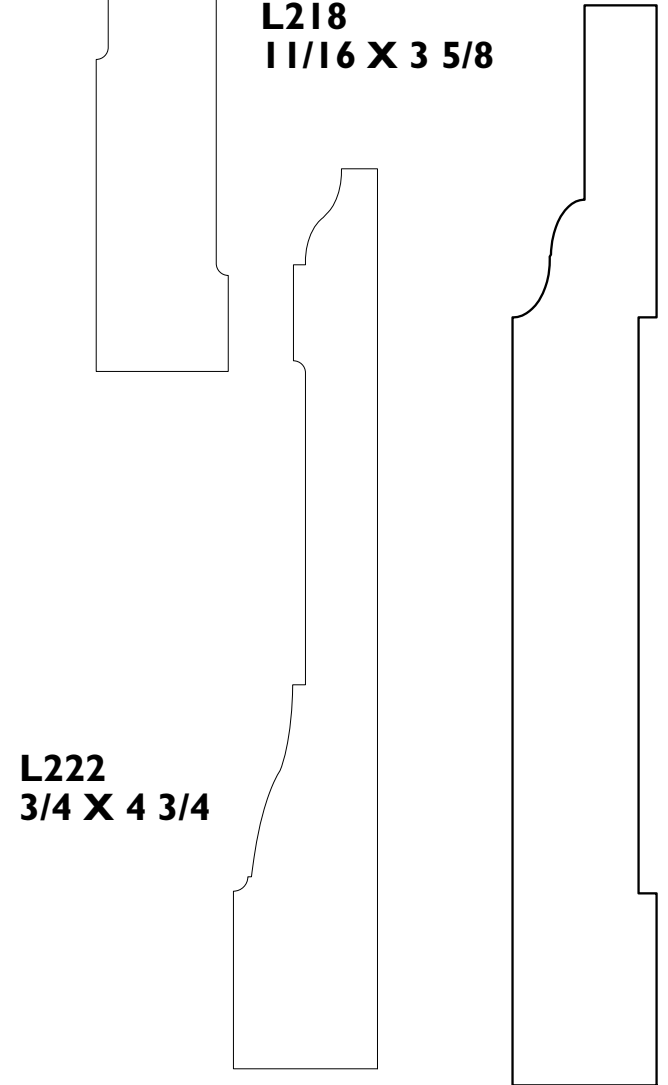
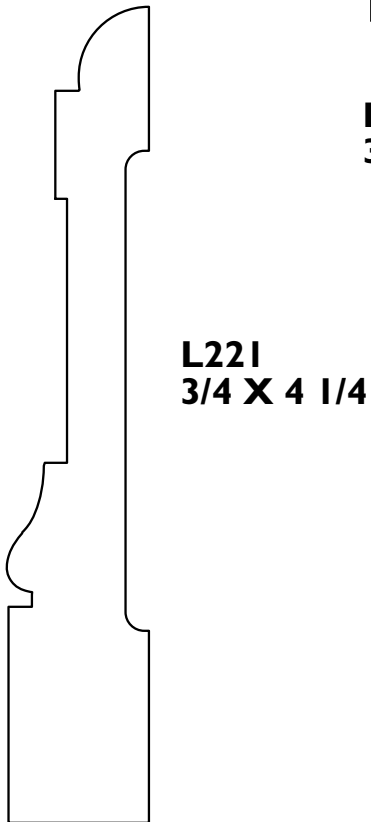
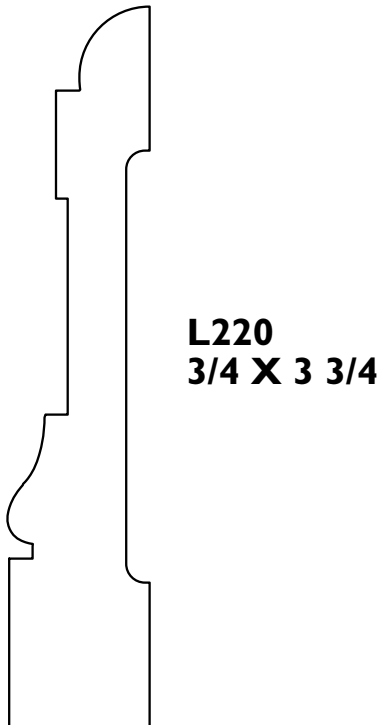
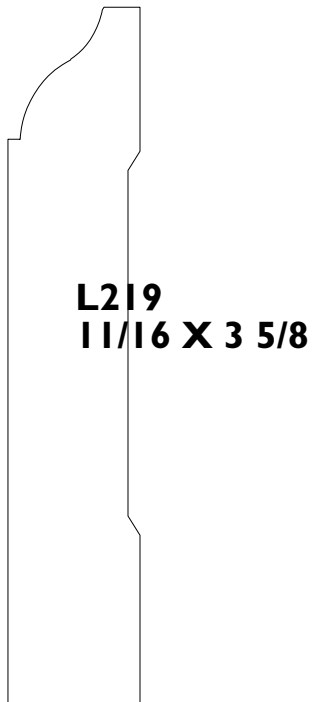
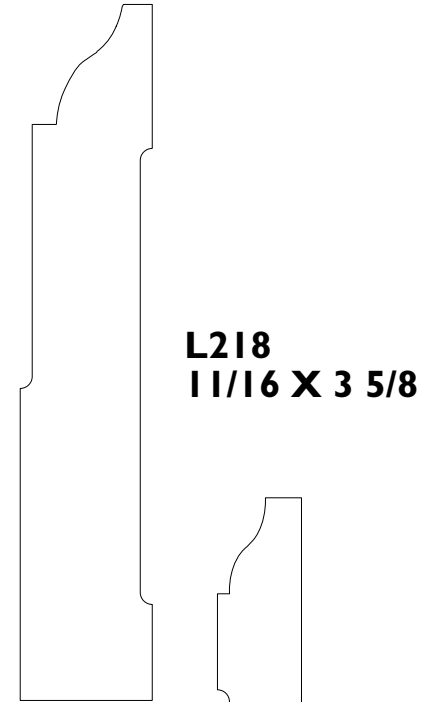
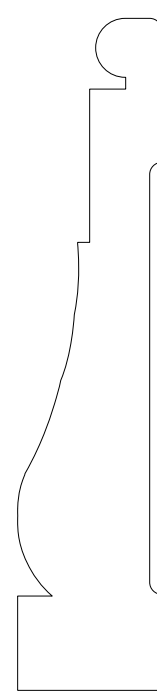
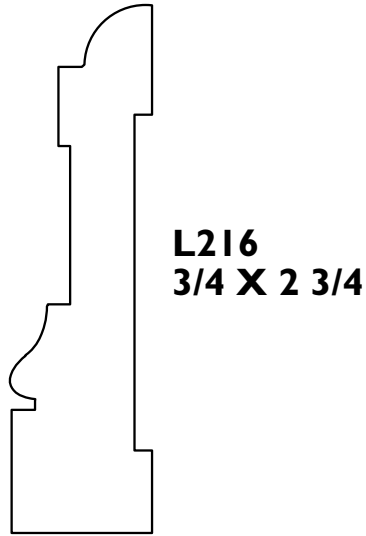
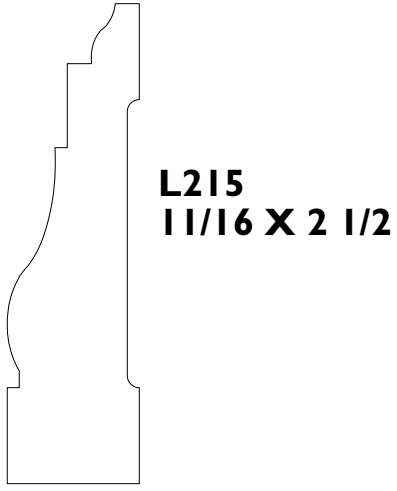
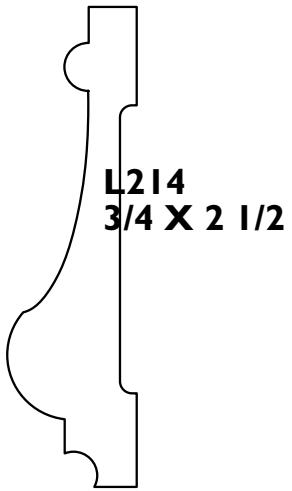

19 AUGUST 96

ACTUAL SCALE

RABBETED BASE

L170
3/4 X 5 5/8

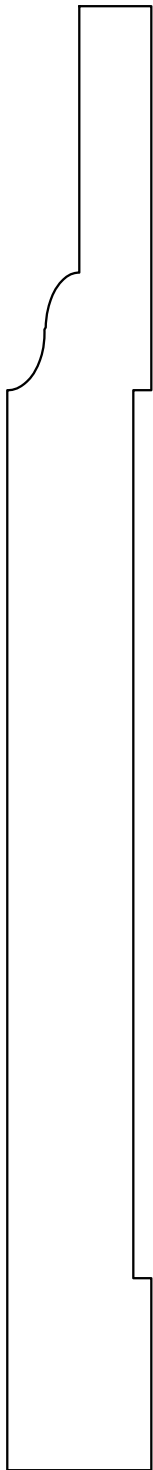

L171
3/4 X 7 5/8



PICTURE MOULDINGS

L167
1 1/16 X 1 3/8

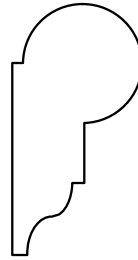

L168
3/4 X 1 3/4

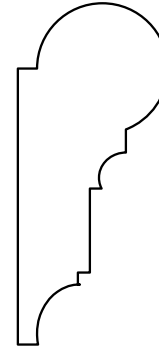

L169
3/4 X 2 1/4

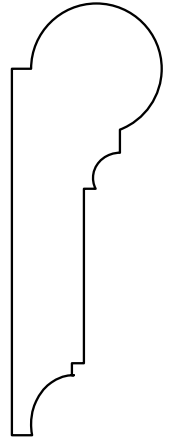

L222
3/4 X 4 3/4

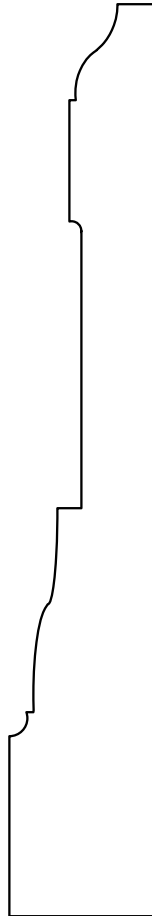

L221
3/4 X 4 1/4

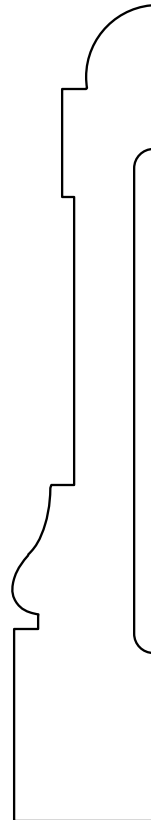

L220
3/4 X 3 3/4

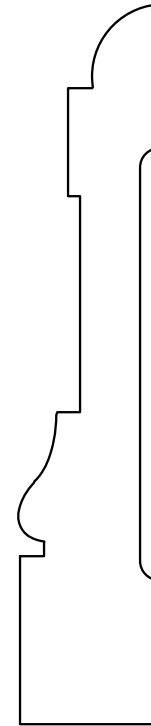

CASING

19 AUGUST 96

ACTUAL SCALE

FLAT ASTRAGALS AND PILASTERS

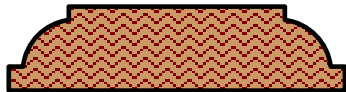

L208
7/16 X 1 3/4



L209
7/16 X 1 3/8



L210
7/16 X 2 1/4

PANEL MOULDINGS



L174
3/8 X 3/4

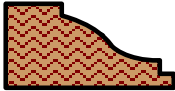

L175
7/16 X 7/8

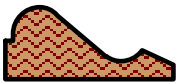

L176
3/8 X 7/8

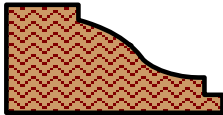

L177
9/16 X 1 1/8

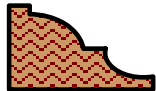

L178
7/16 X 3/4

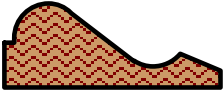

L179
7/16 X 3/4

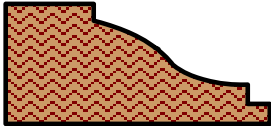

L180
5/8 X 1 3/8

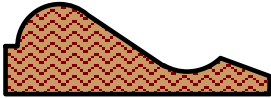

L181
7/16 X 1 3/8

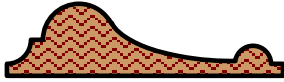

L182
3/8 X 1 3/8

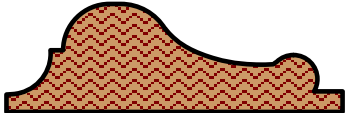

L183
9/16 X 1 3/4

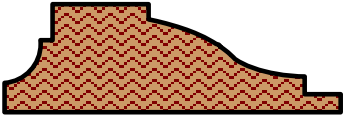

L184
9/16 X 1 3/4

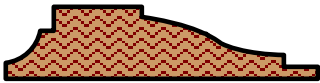

L185
3/8 X 1 3/8

HALF ROUNDS



L29
3/16 X 3/8



L30
1/4 X 1/2



L31
5/16 X 5/8

L32
3/8 X 3/4

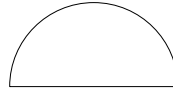

L33
7/16 X 7/8

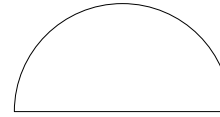

L34
9/16 X 1 1/8



L35
3/8 X 1 1/8

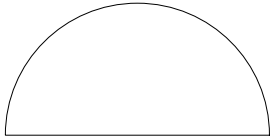

L36
11/16 X 1 3/8

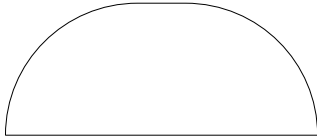

L37
11/16 X 1 5/8

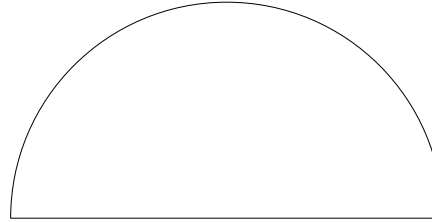

L38
1 1/8 X 2 1/4

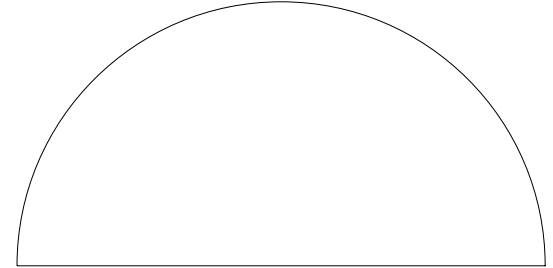

L39
1 3/8 X 2 3/4

WINDOW STOPS

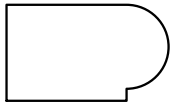

L198
1/2 X 7/8



L199
9/16 X 1 1/8

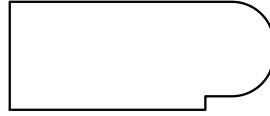

L200
9/16 X 1 3/8

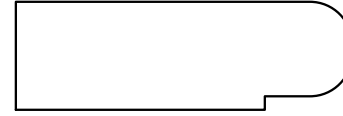

L201
9/16 X 1 3/4

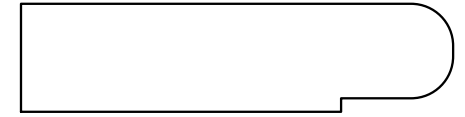

L202
9/16 X 2 1/4

BOX PILASTERS

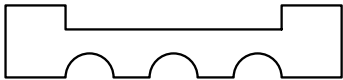

L211
3/8 X 1 3/4

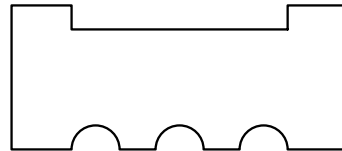

L212
3/4 X 1 3/4

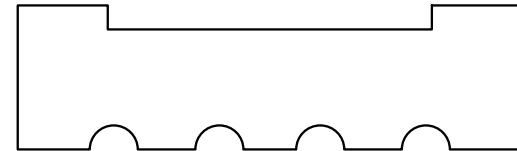

L213
3/4 X 2 5/8

DOOR STOPS



L191
1/2 X 3/4



L193
3/8 X 1 1/8



L195
3/8 X 1 5/8

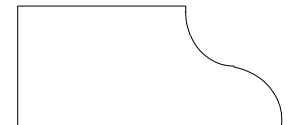

L197
5/8 X 1 3/8

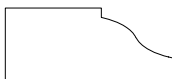

L192
3/8 X 7/8



L194
3/8 X 1 3/8



L196
3/8 X 2 1/4

WINDOW STOPS

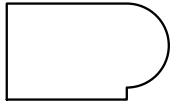

L198
1/2 X 7/8

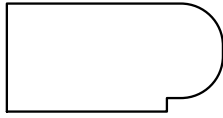

L199
9/16 X 1 1/8

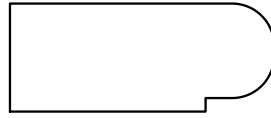

L200
9/16 X 1 3/8

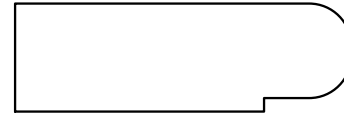

L201
9/16 X 1 3/4

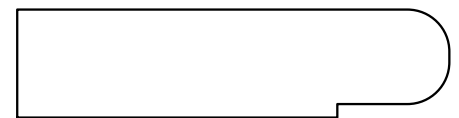

L202
9/16 X 2 1/4

BOX PILASTERS

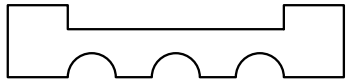

L211
3/8 X 1 3/4

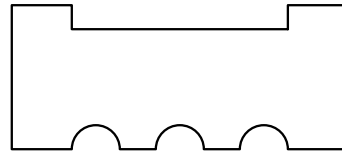

L212
3/4 X 1 3/4

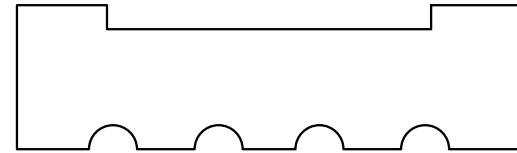

L213
3/4 X 2 5/8

DOOR STOPS

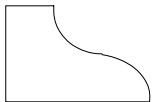

L191
1/2 X 3/4



L193
3/8 X 1 1/8



L195
3/8 X 1 5/8

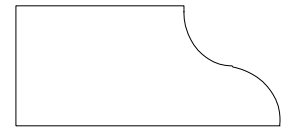

L197
5/8 X 1 3/8



L192
3/8 X 7/8



L194
3/8 X 1 3/8



L196
3/8 X 2 1/4

HALF ROUNDS

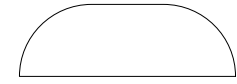
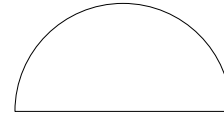
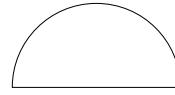

L29
3/16 X 3/8

L30
1/4 X 1/2

L31
5/16 X 5/8

L32
3/8 X 3/4

L33
7/16 X 7/8

L34
9/16 X 1 1/8

L35
3/8 X 1 1/8

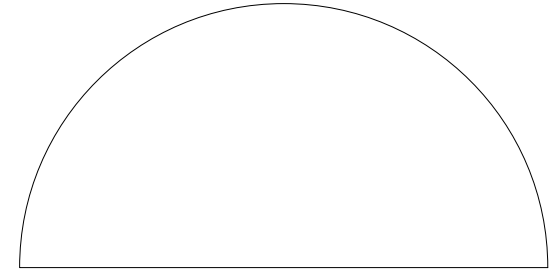
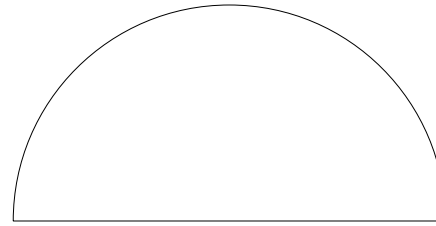
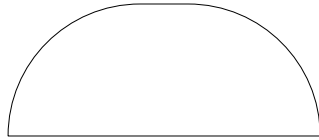
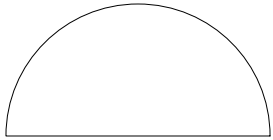

L36
11/16 X 1 3/8

L37
11/16 X 1 5/8

L38
1 1/8 X 2 1/4

L39
1 3/8 X 2 3/4

SHELF EDGES



L40
1/4 X 13/16

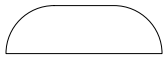

L41
1/4 X 13/16

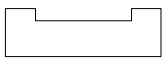

L42
1/4 X 13/16



L43
1/4 X 3/4

QUARTER ROUNDS



L44
1/4 X 1/4



L45
3/8 X 3/8

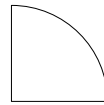

L46
1/2 X 1/2

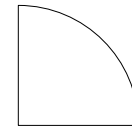

L47
5/8 X 5/8

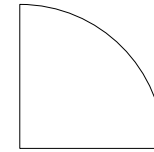

L48
3/4 X 3/4

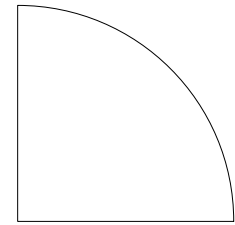

L49
1 1/8 X 1 1/8

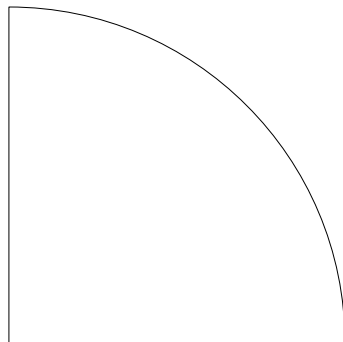

L51
1 3/4 X 1 3/4

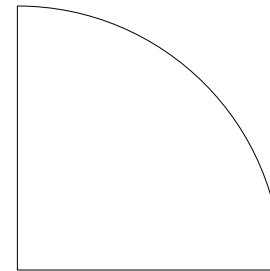

L50
1 3/8 X 1 3/8

21 AUGUST 96

ACTUAL SCALE

COVES

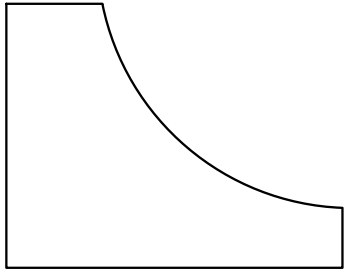

L62
1 3/8 X 1 3/4

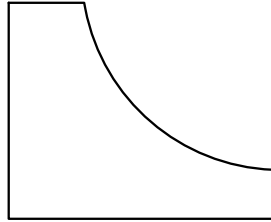

L61
1 1/8 X 1 3/8

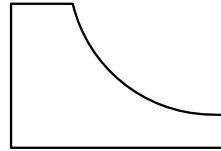

L60
3/4 X 1 1/8

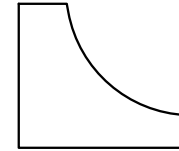

L59
3/4 X 7/8

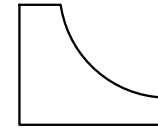

L58
5/8 X 3/4

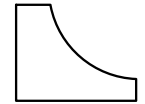

L57
1/2 X 5/8

NOSE AND COVE

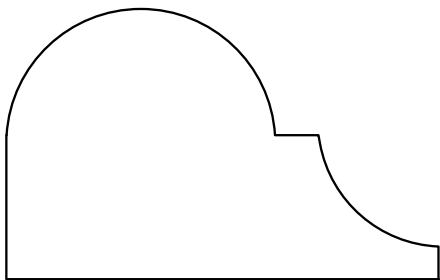

L65
1 3/8 X 2 1/4

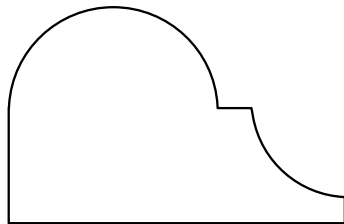

L64
1 1/8 X 1 3/4

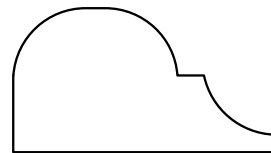

L66
3/4 X 1 3/8

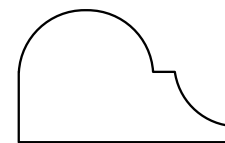

L63
11/16 X 1 1/8

14 AUGUST 96

ACTUAL SCALE

RABBETED BASE

L170
3/4 X 5 5/8

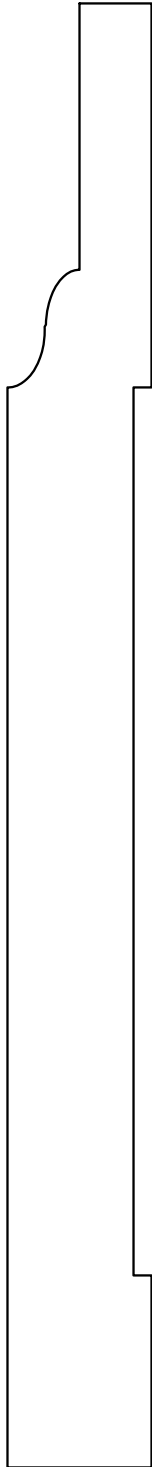
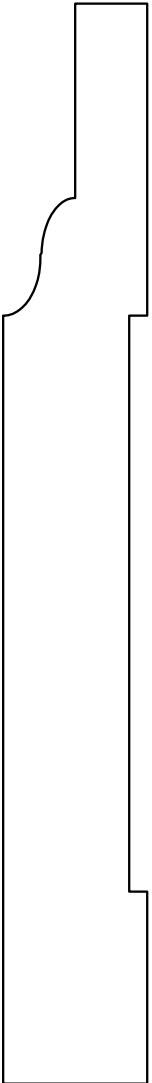

L171
3/4 X 7 5/8

PICTURE MOULDINGS

L167
11/16 X 1 3/8

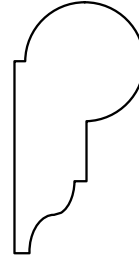

L168
3/4 X 1 3/4

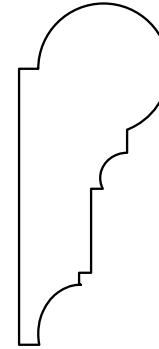

L169
3/4 X 2 1/4

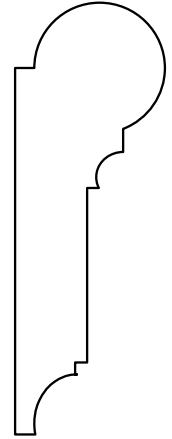

L222
3/4 X 4 3/4

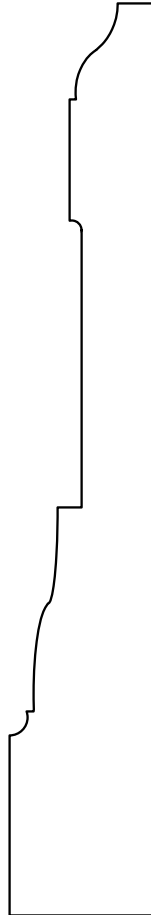

L221
3/4 X 4 1/4

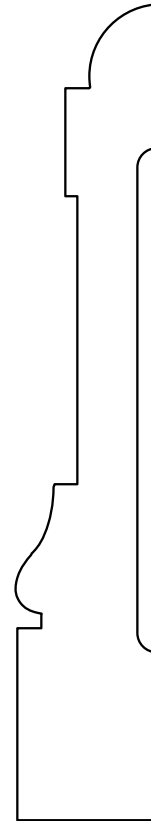

L220
3/4 X 3 3/4

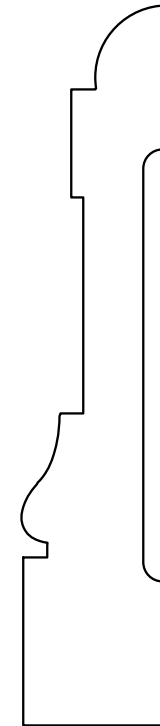

CASING

19 AUGUST 96

ACTUAL SCALE